

**1** TOWER SECTION  
SCALE: 3/4" = 1'-0"

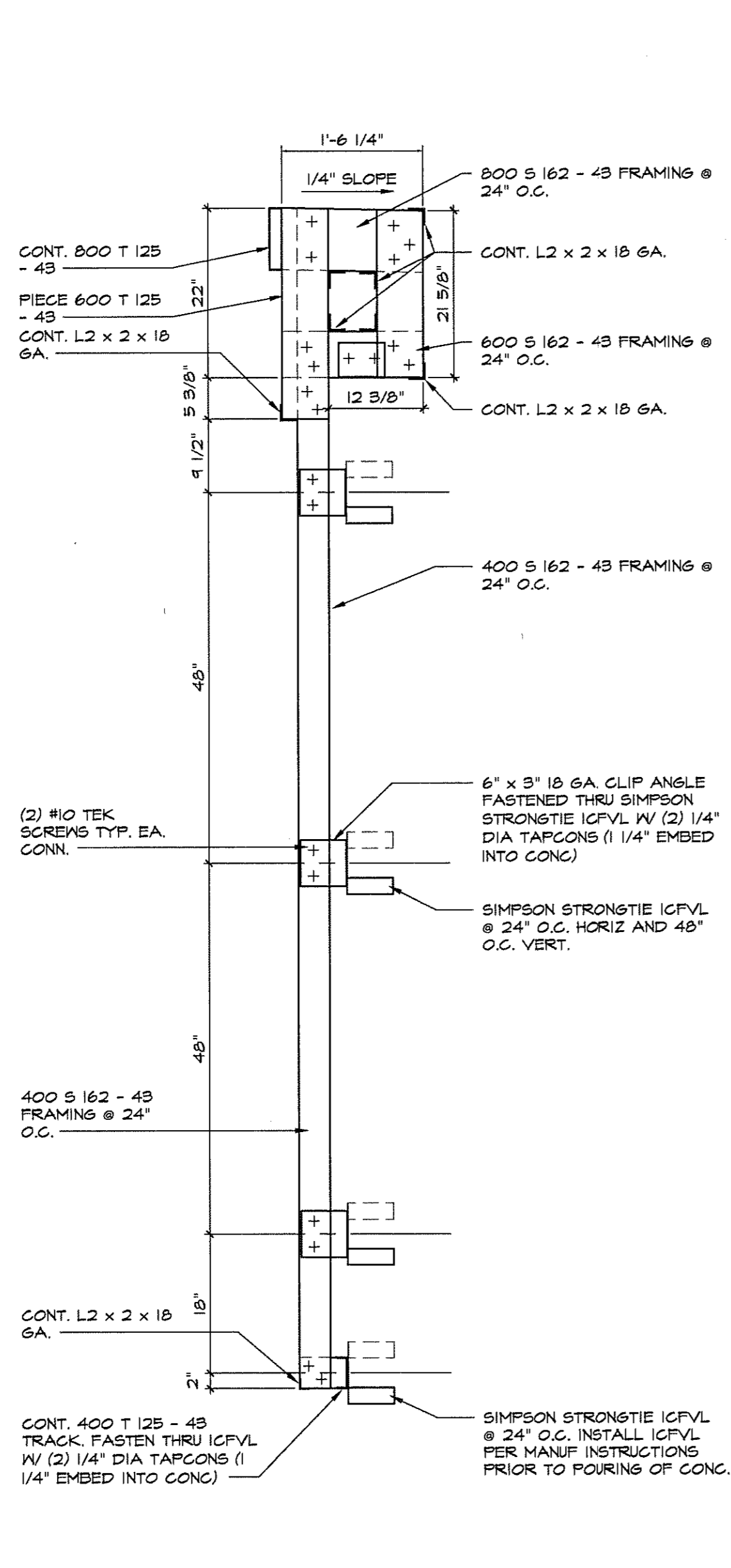

**2** TOWER FRAMING  
SCALE: 3/4" = 1'-0"

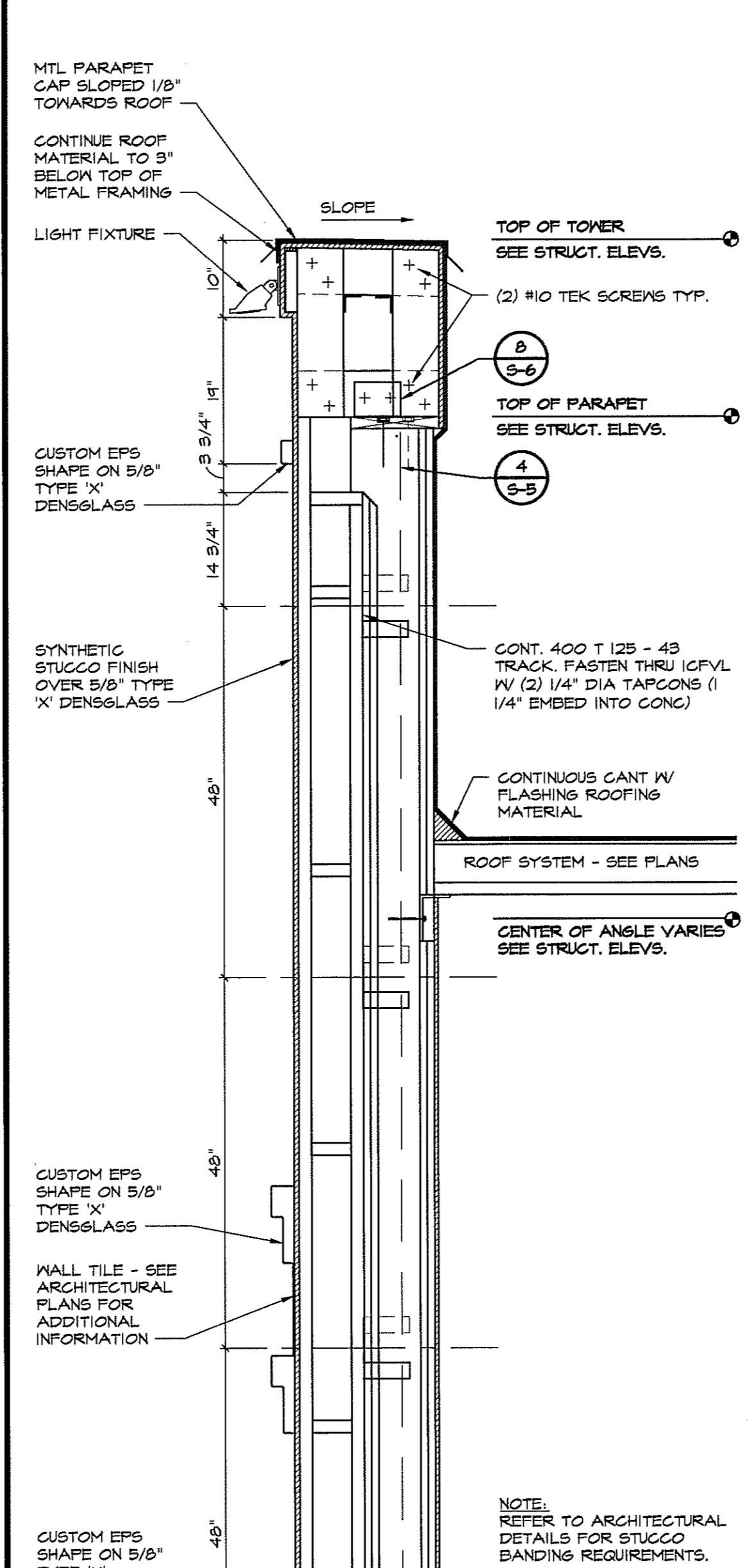

**3** COLUMN SECTION  
SCALE: 3/4" = 1'-0"

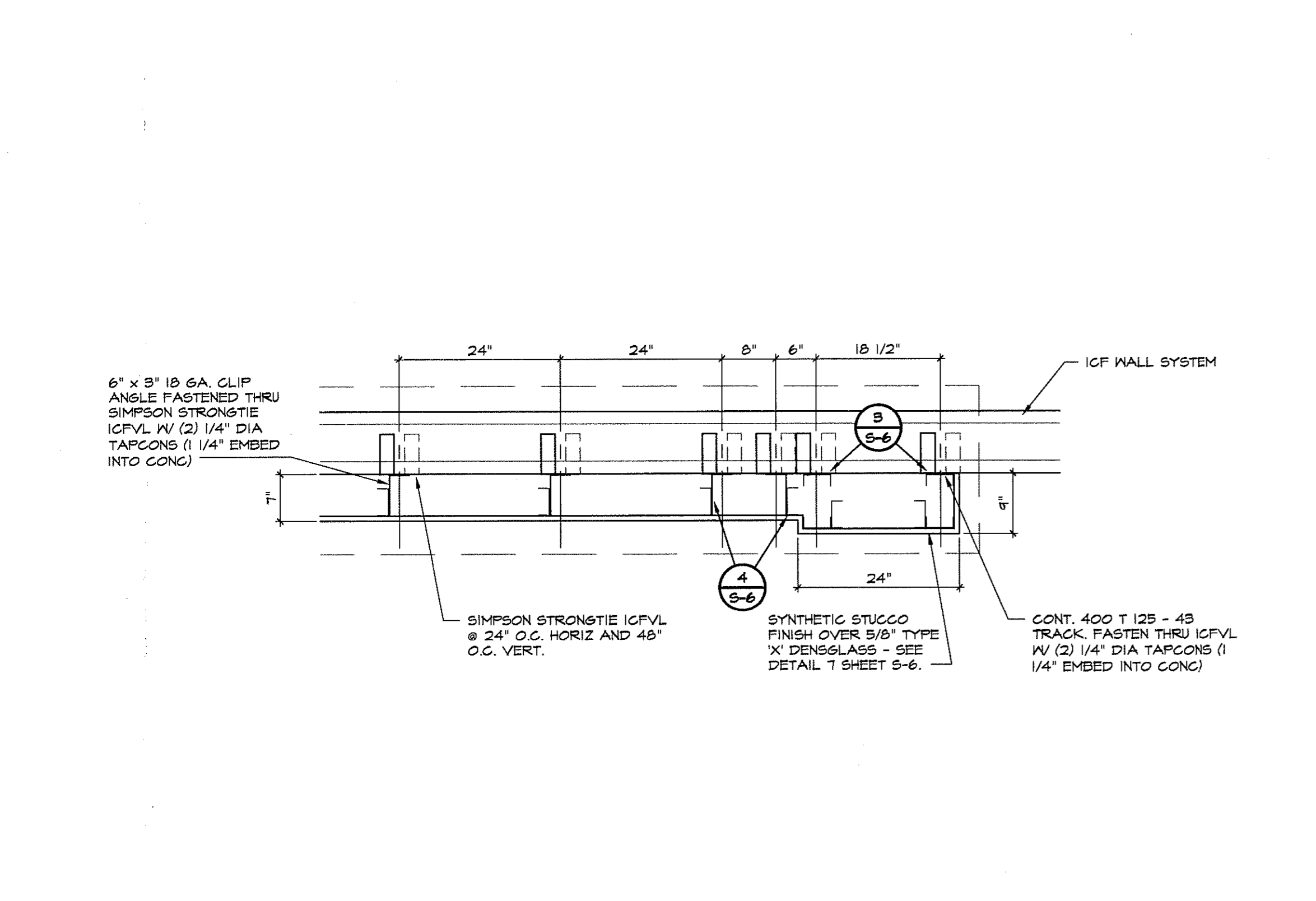

**4** TOWER SECTION  
SCALE: 3/4" = 1'-0"

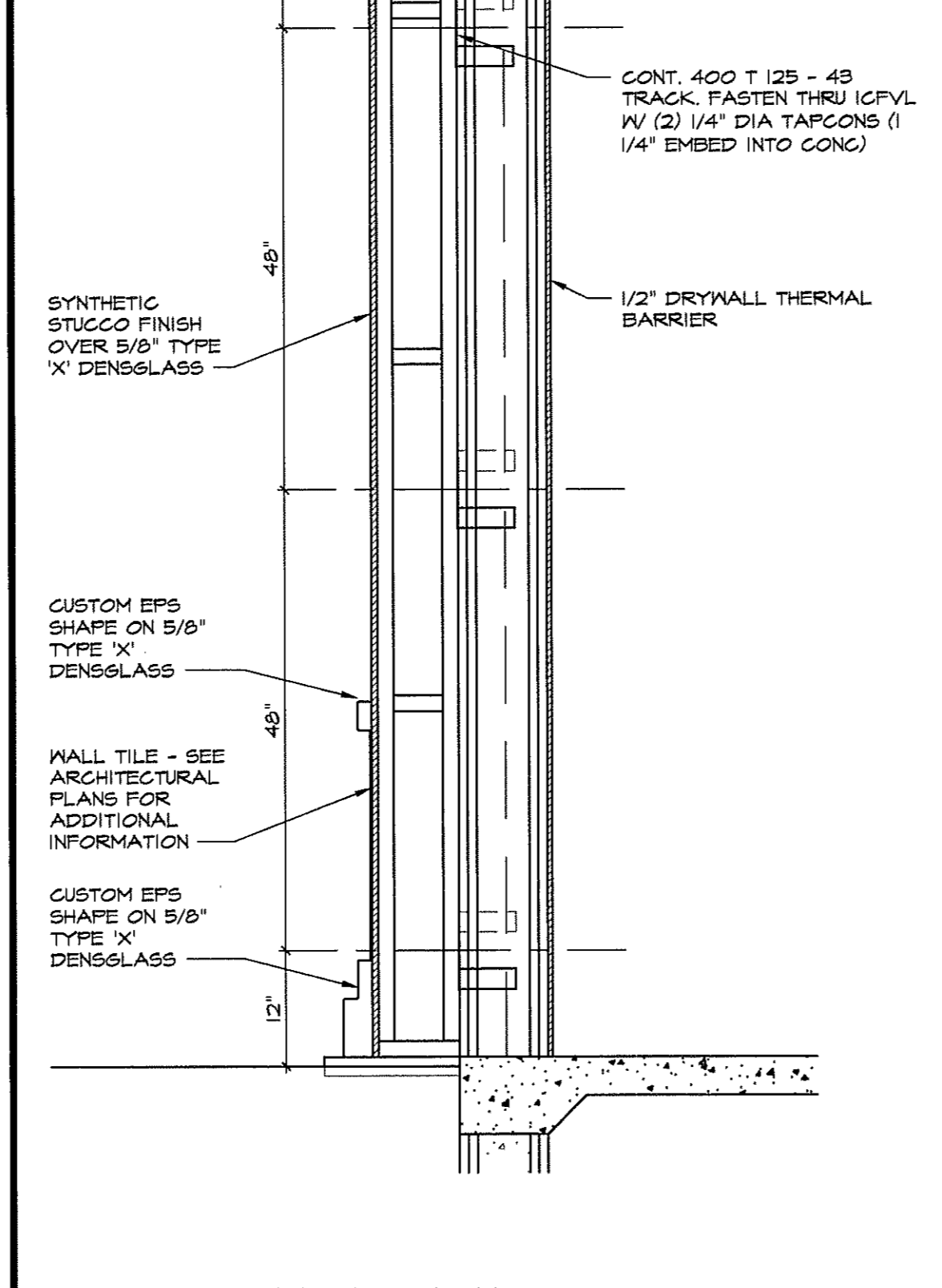

**5** COLUMN SECTION  
SCALE: 3/4" = 1'-0"

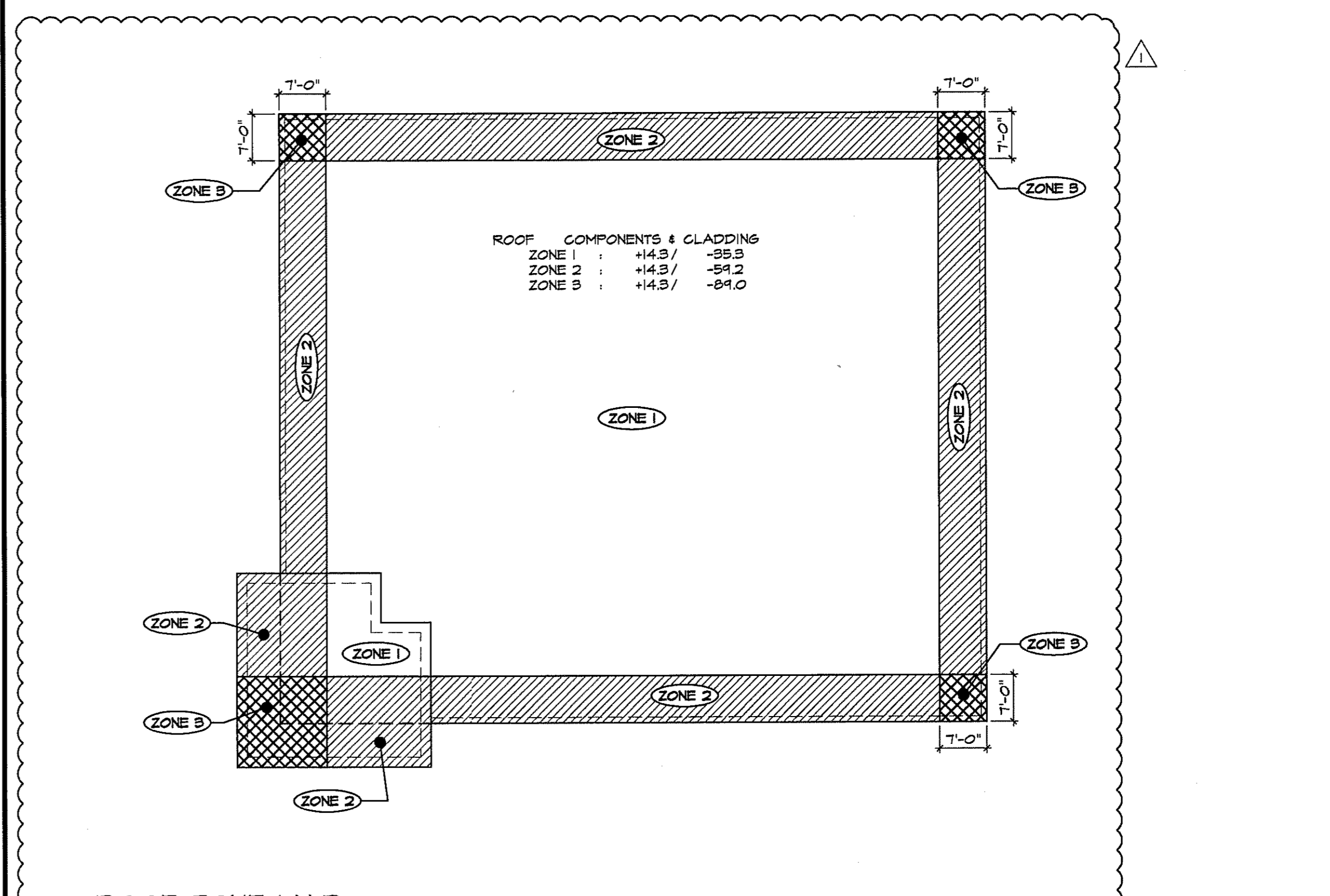
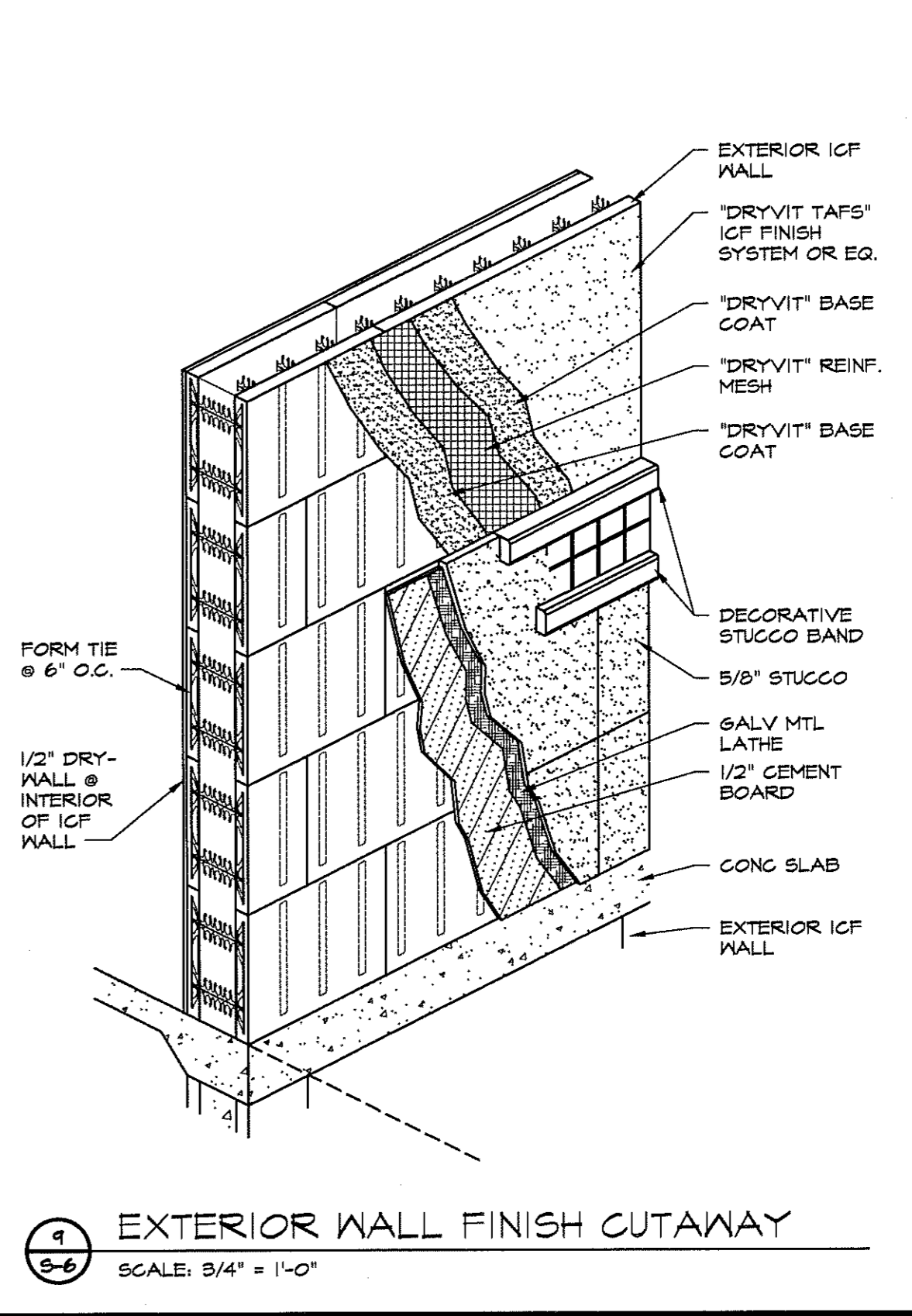
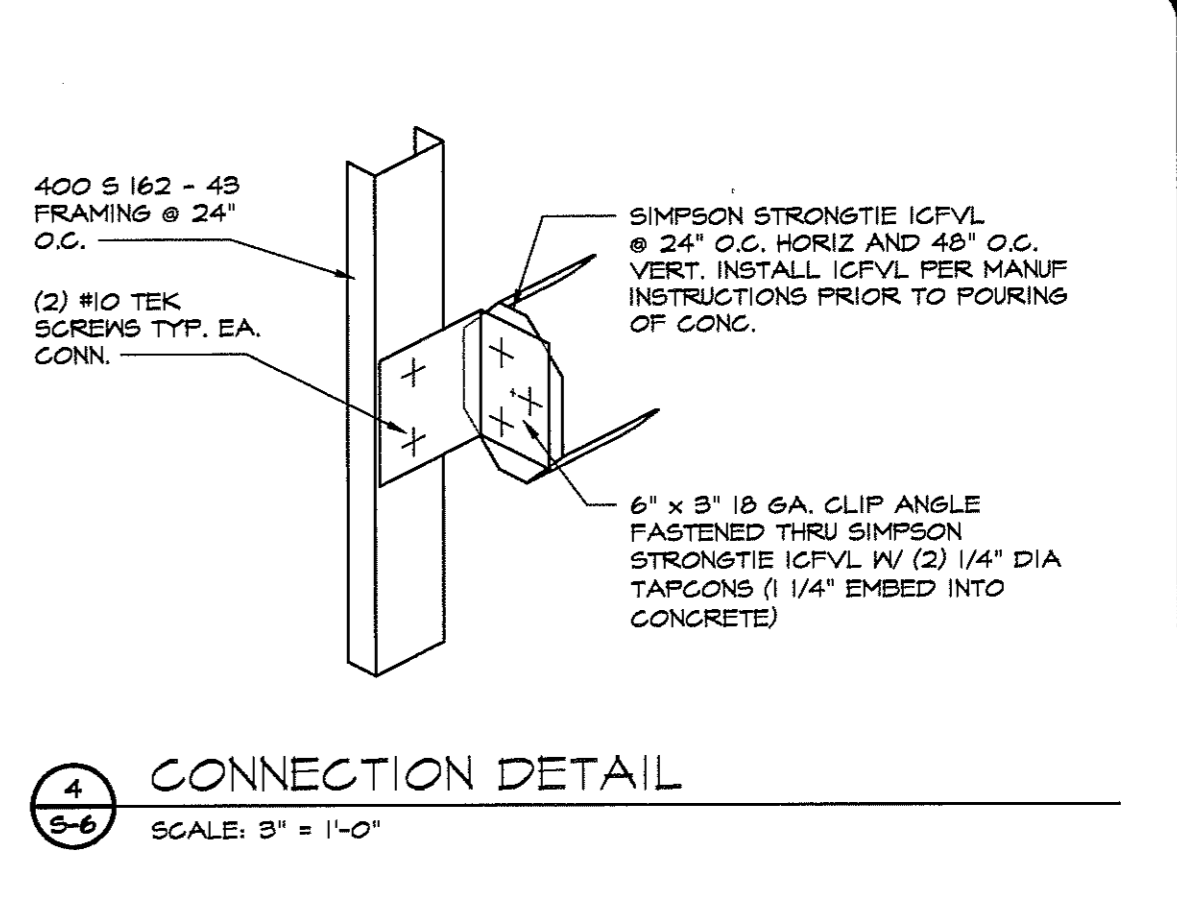
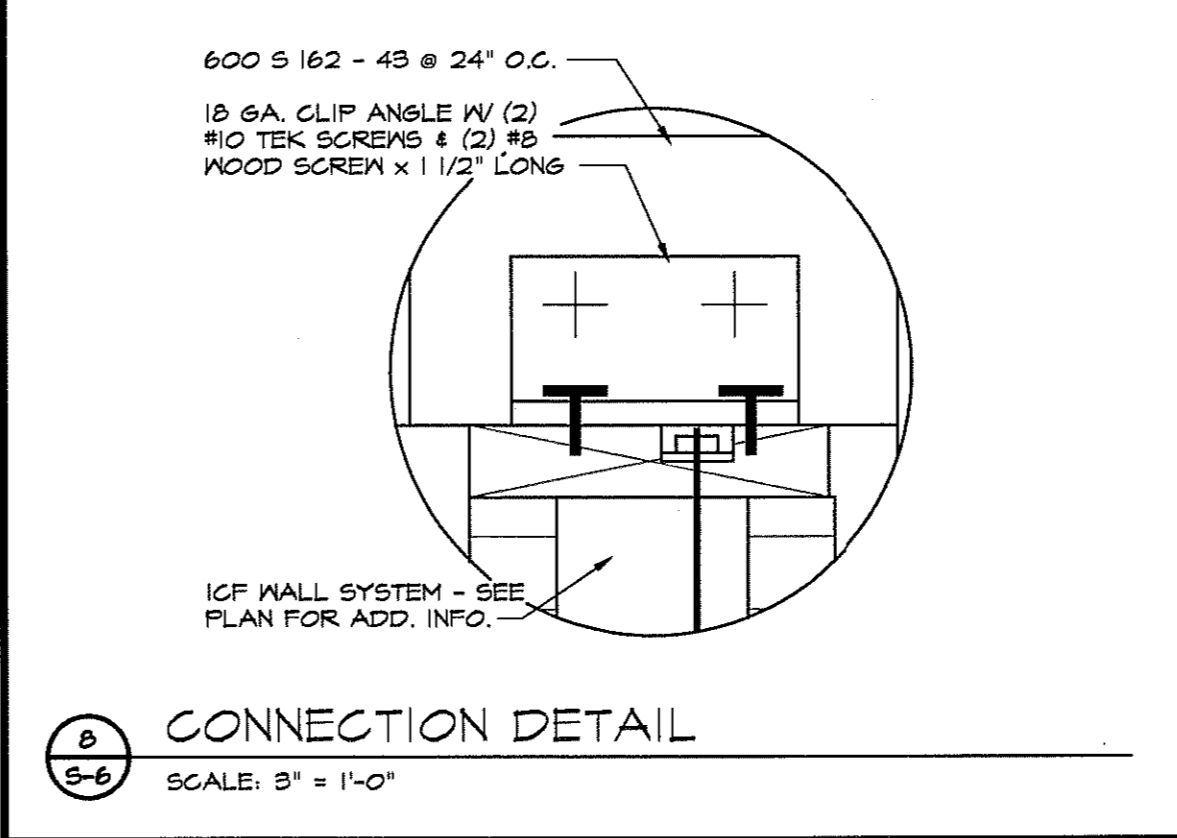
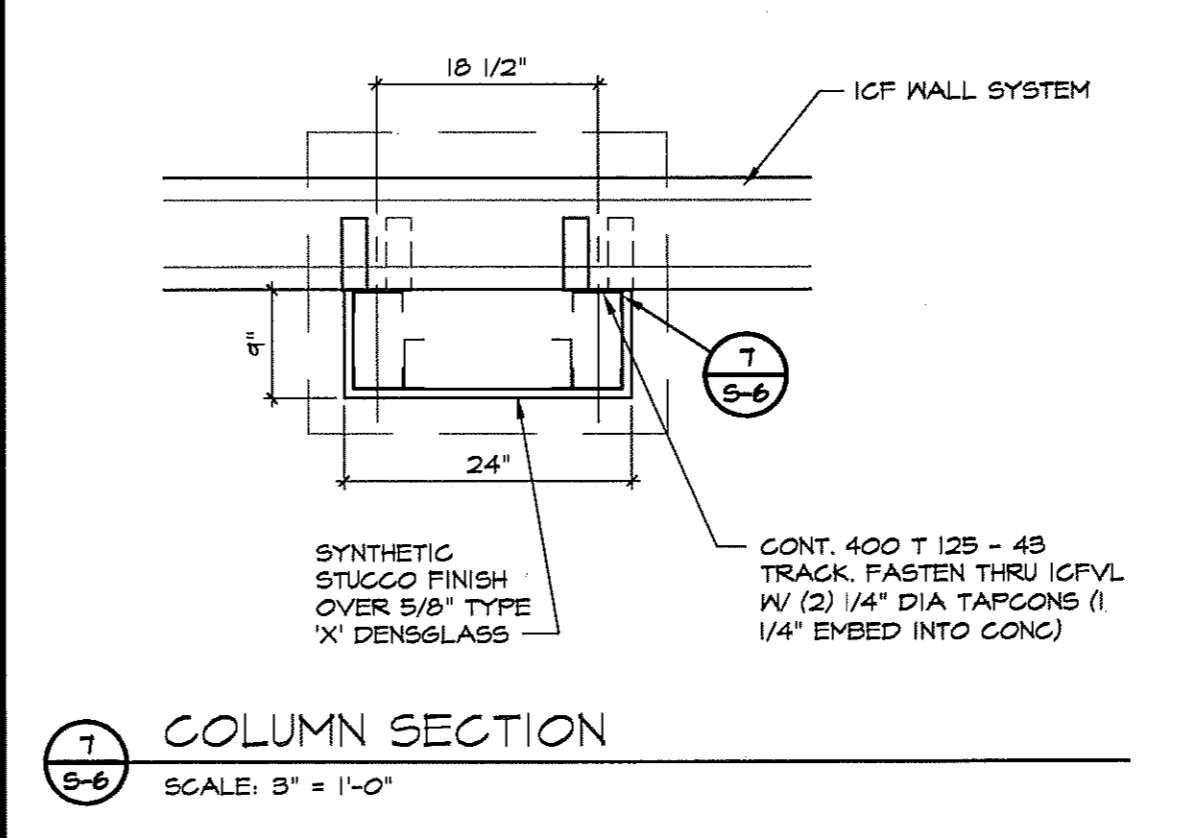
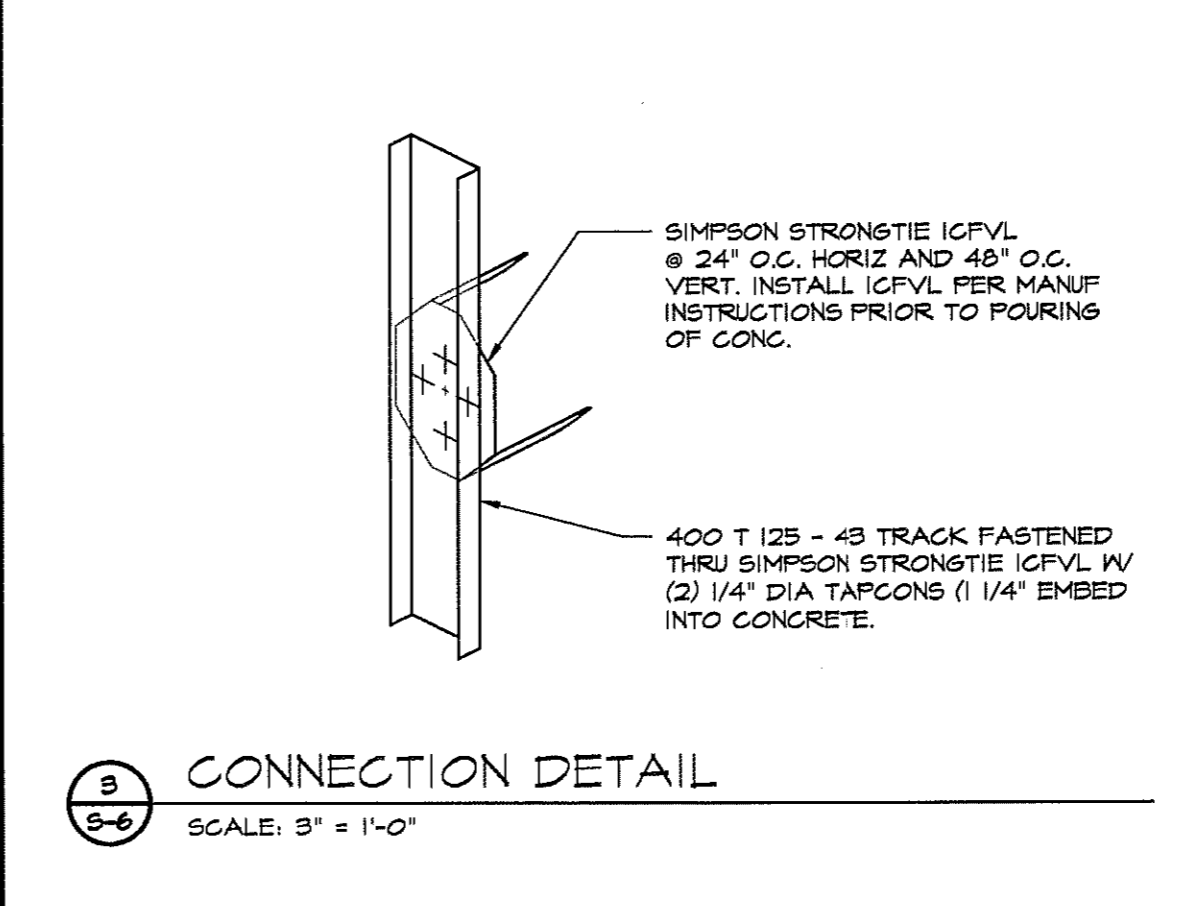

REVISIONS BY

BUILDING DEPT	MCM
REVISION	1-26-10

**Lindemann** 290 CITRUS TOWER BLVD. SUITE 200 CLEMONT, FLORIDA 34711

**Bentzon** PHONE: (352) 242-0100

**Bojack** FAX: (352) 242-0302

ENGINEERING DESIGN INSPECTION

FL Lic. No. 12000  
Professional Engineer  
Civil  
Certificate No. EB-0009372

JAN 2 2010

**ABC LIQUORS, INC.**

8888 S. ORANGE AVE. - ORLANDO, FLA. 32809

**ABC STORE NO. 43**

VERO BEACH CENTURY TOWN CENTER

STRUCTURAL DETAILS

DRAWN:	M. MAISCO
CHECKED:	S. RIVERA
DATE:	5-15-04
SCALE:	AS NOTED
JOB No:	43
SHEET	

S-6