

**EXTERIOR WALL HYDRANT DETAIL**  
NOT TO SCALE

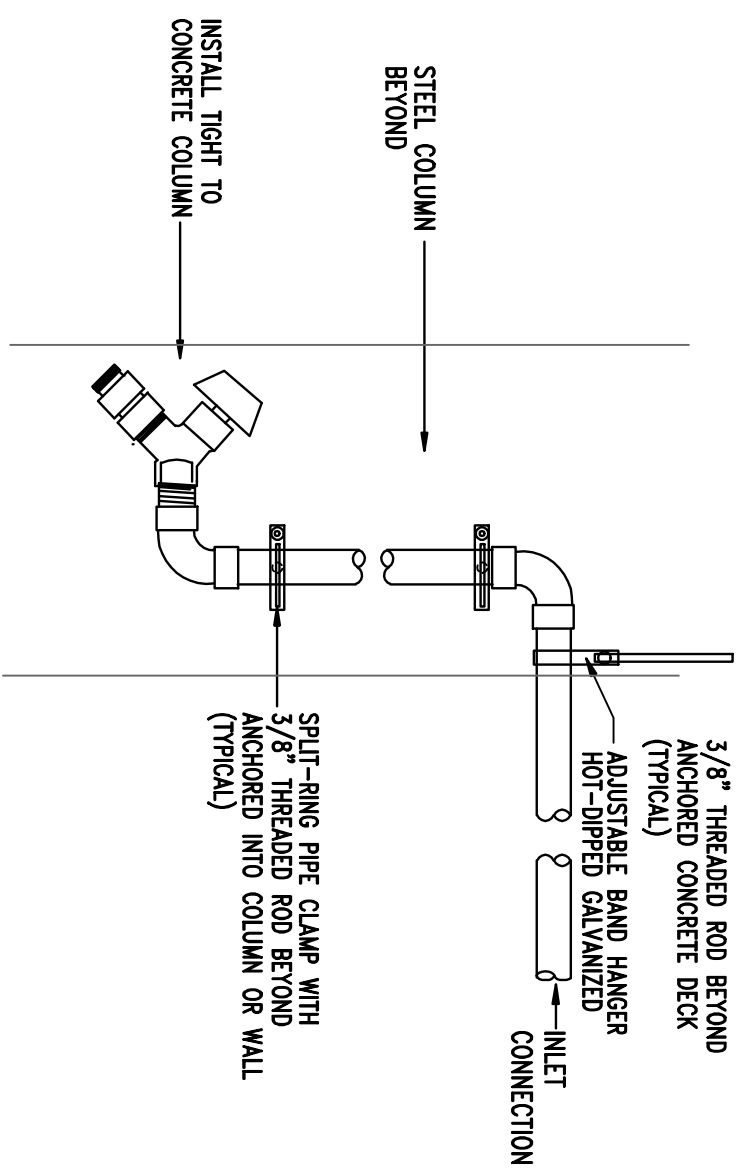

**INTERIOR HOSE BIBB DETAIL**  
NOT TO SCALE

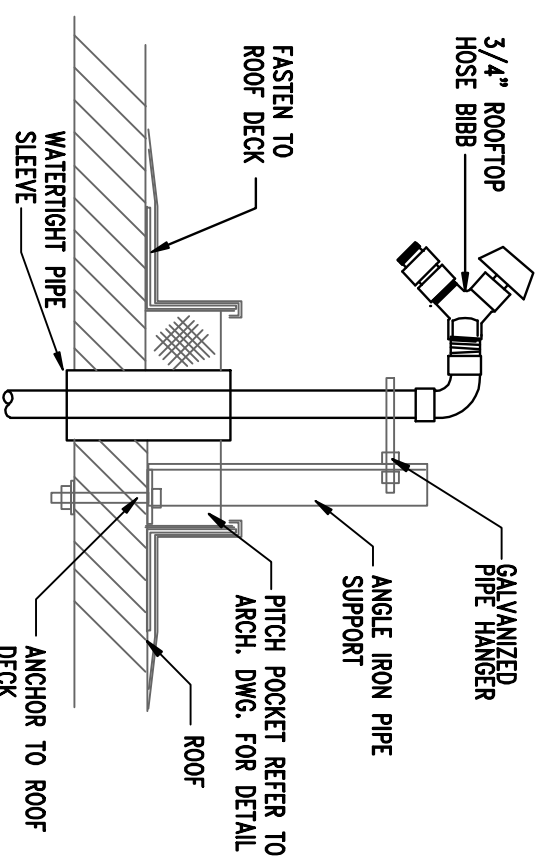

**ROOFTOP HOSE BIBB DETAIL**  
NOT TO SCALE

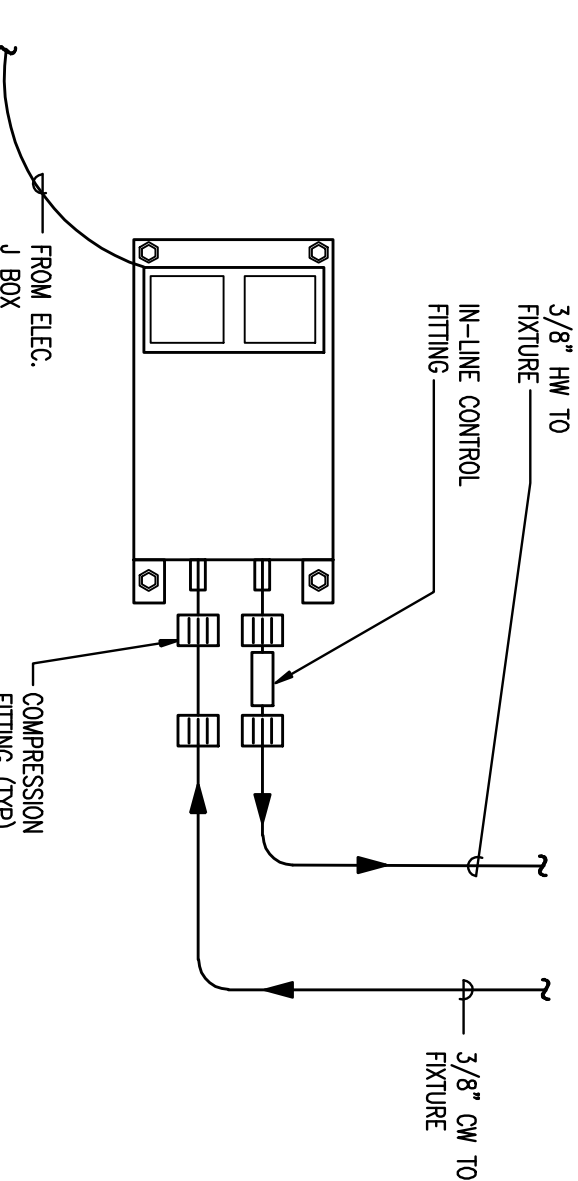

**INSTANTANEOUS WATER HEATER DETAIL**  
NOT TO SCALE

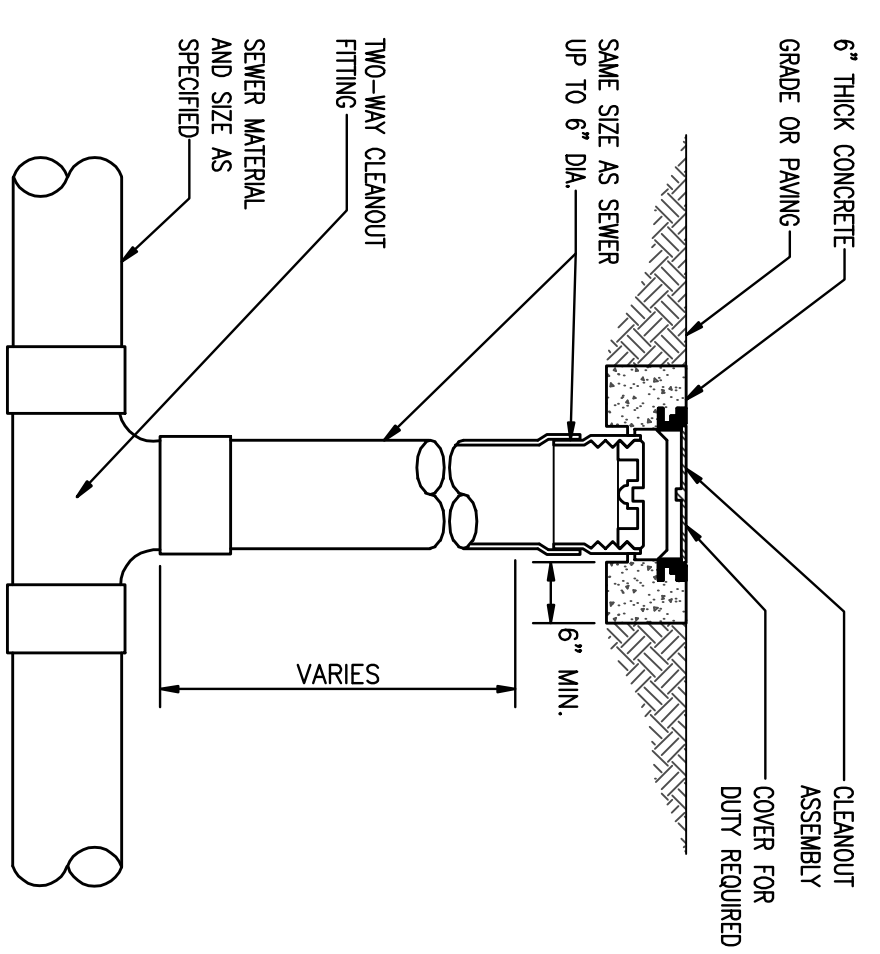

**2 WAY GRADE CLEANOUT DETAIL**  
NOT TO SCALE

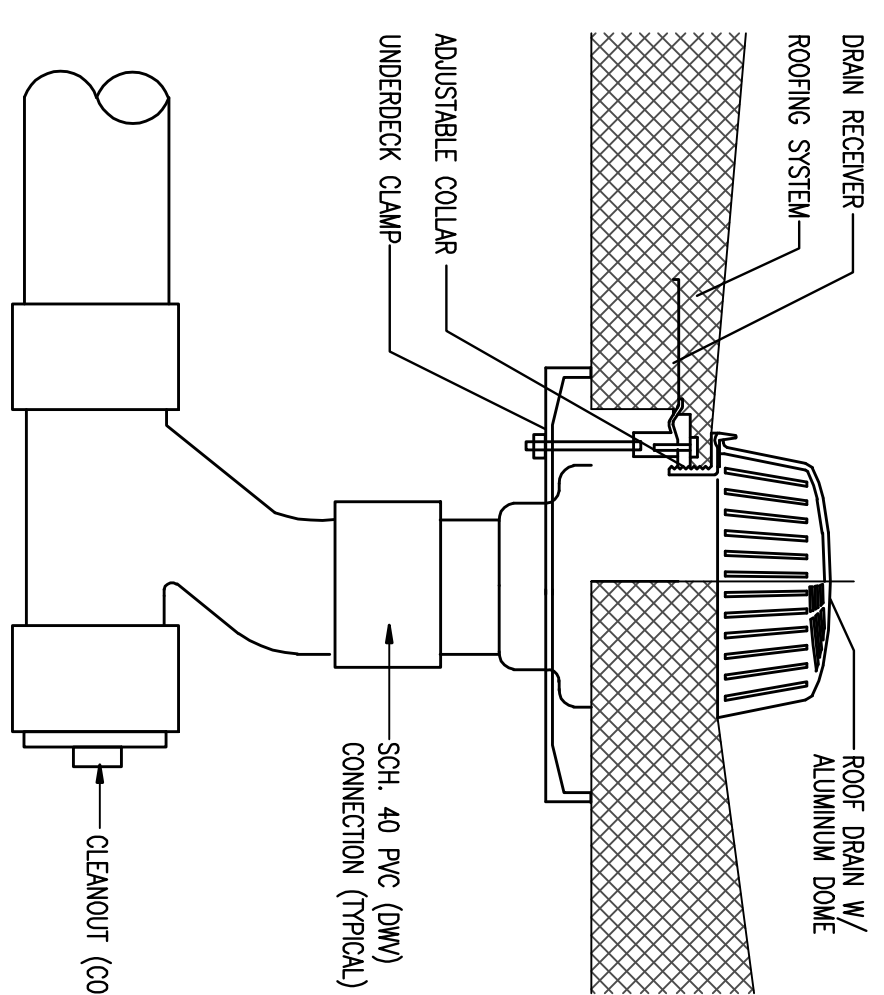

**ROOF DRAIN DETAIL**  
NOT TO SCALE

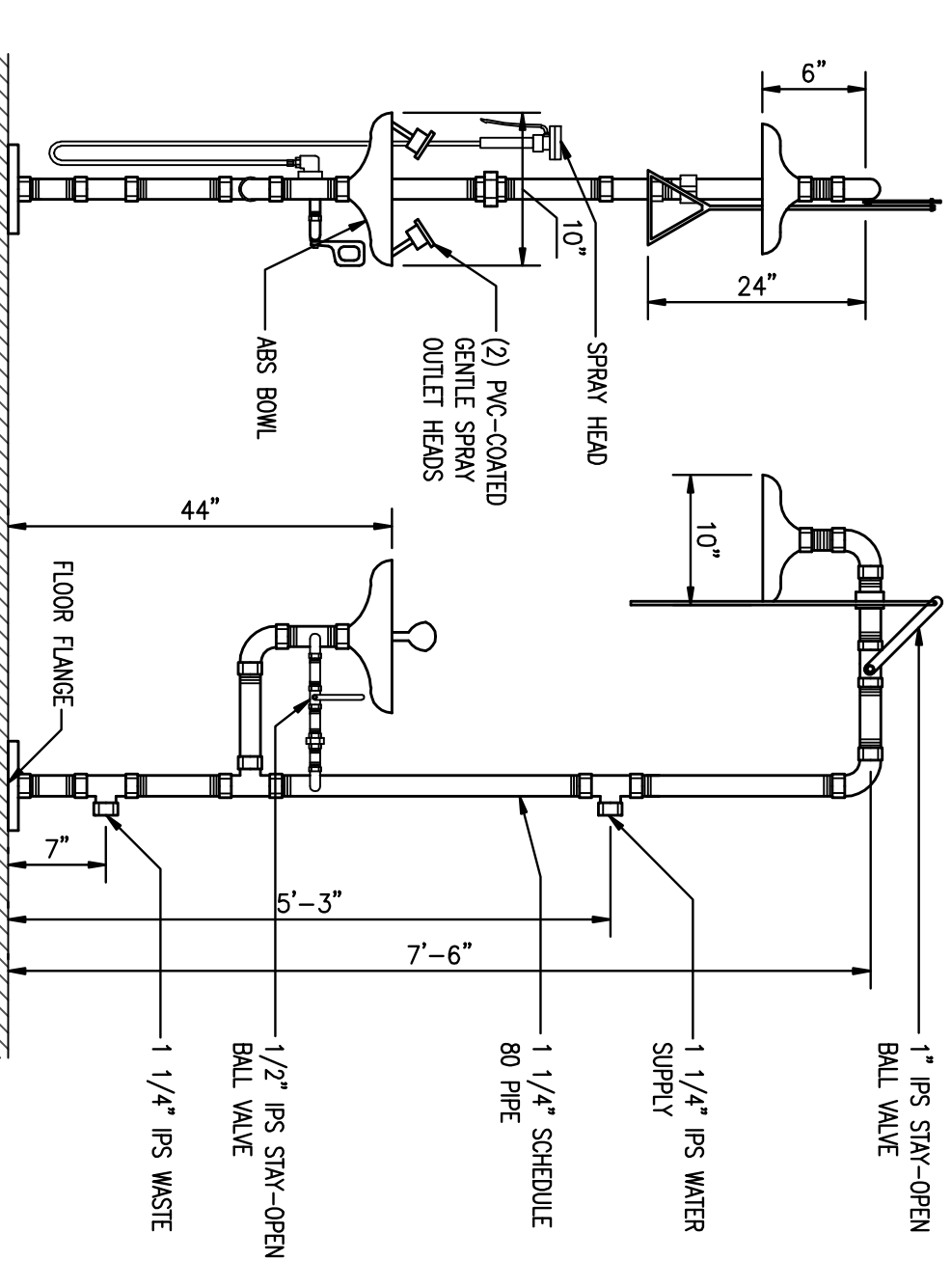

**EMERGENCY SHOWER / EYEWASH**  
NOT TO SCALE

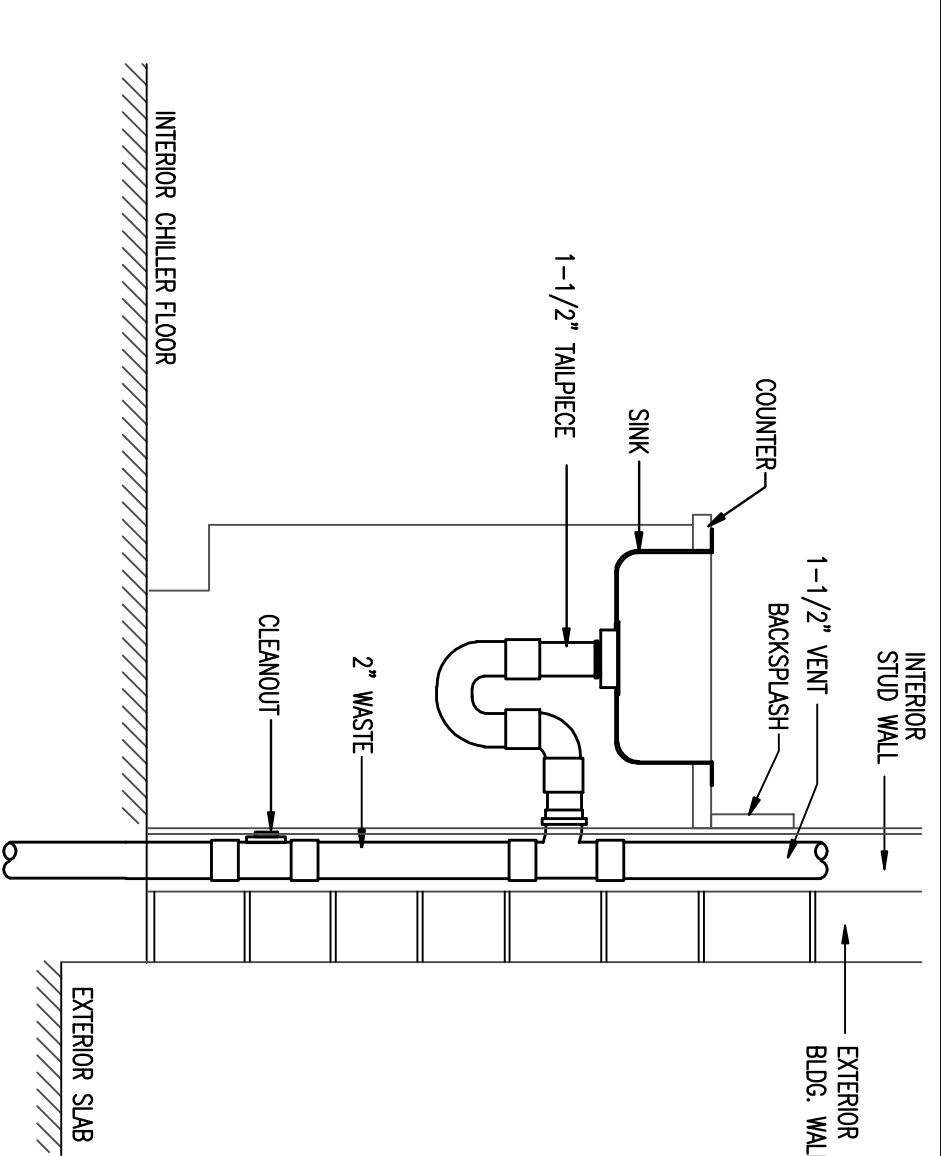

**SINK DETAIL**  
NOT TO SCALE

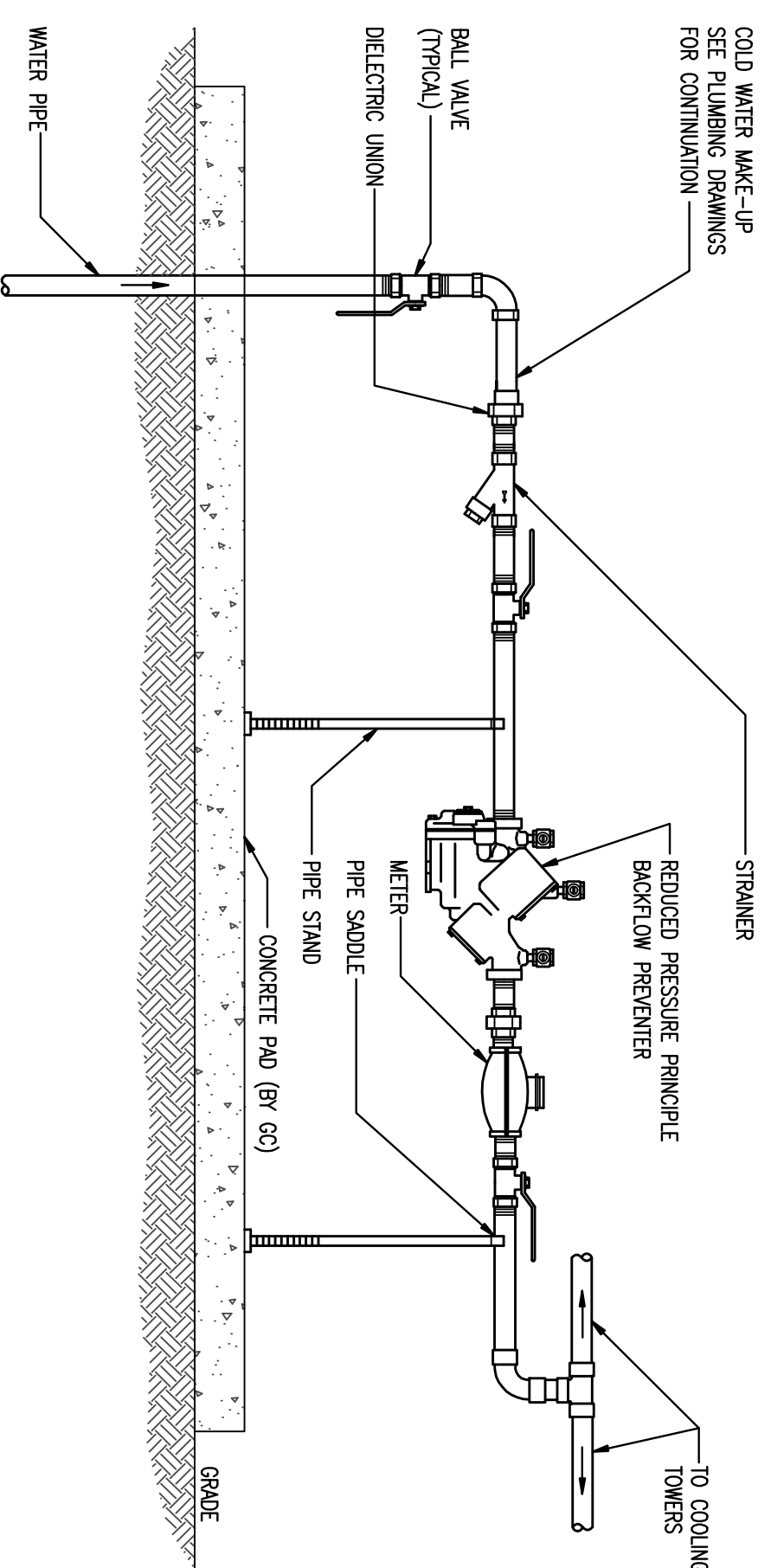

**COOLING TOWER MAKE-UP WATER DETAIL**  
NOT TO SCALE

- NOTES**
1. DEVICE MUST BE INSTALLED LEVEL.
  2. DENOTES OSKY GATE VALVES.
  3. ALL JOINTS SHALL BE FLANGED (U.O.N.)

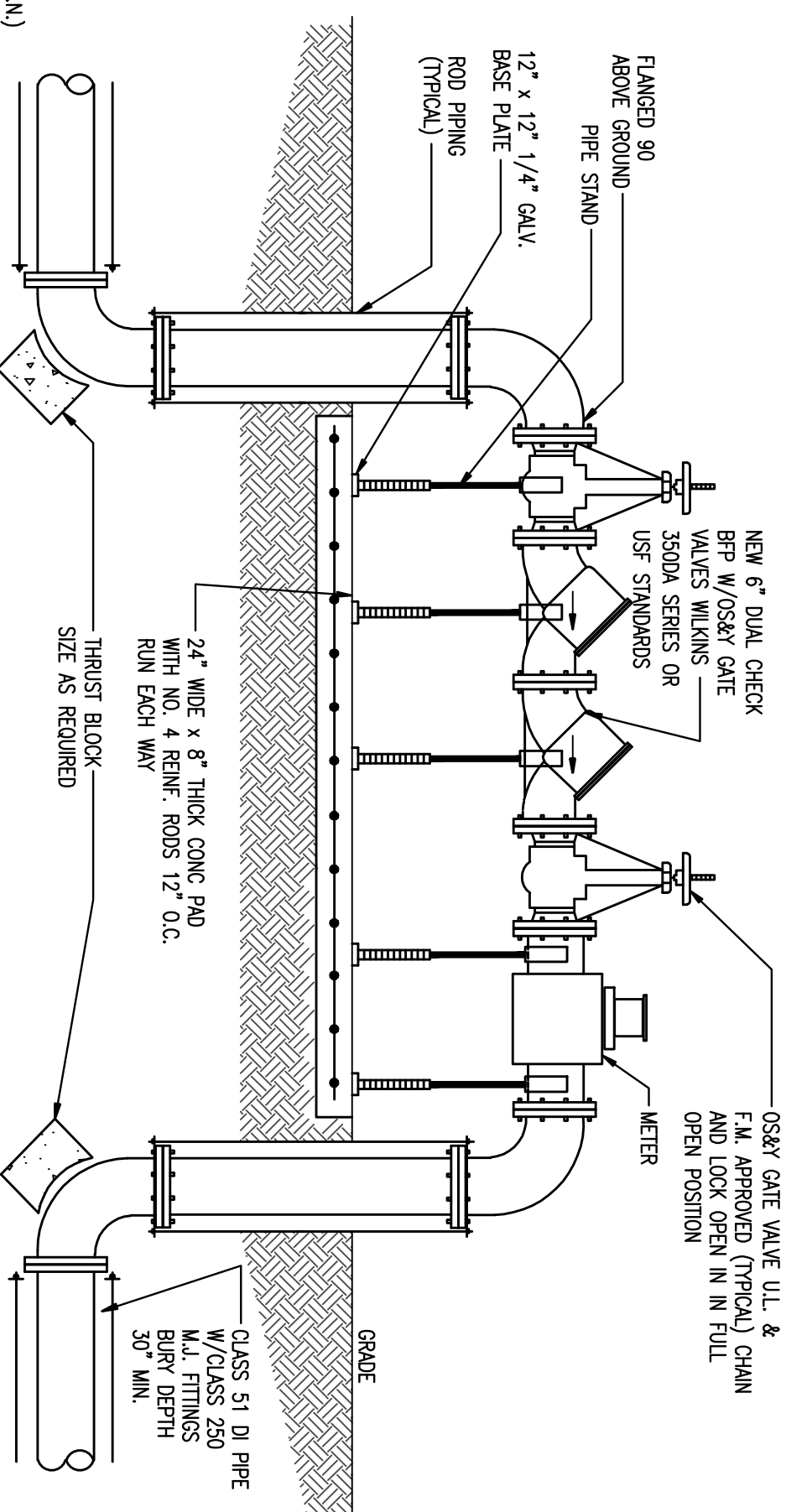

**REDUCED PRESSURE BACKFLOW PREVENTER DETAIL**  
NOT TO SCALE
