

MARKETPLACE EQUIPMENT PLAN

3/16" = 1'-0"

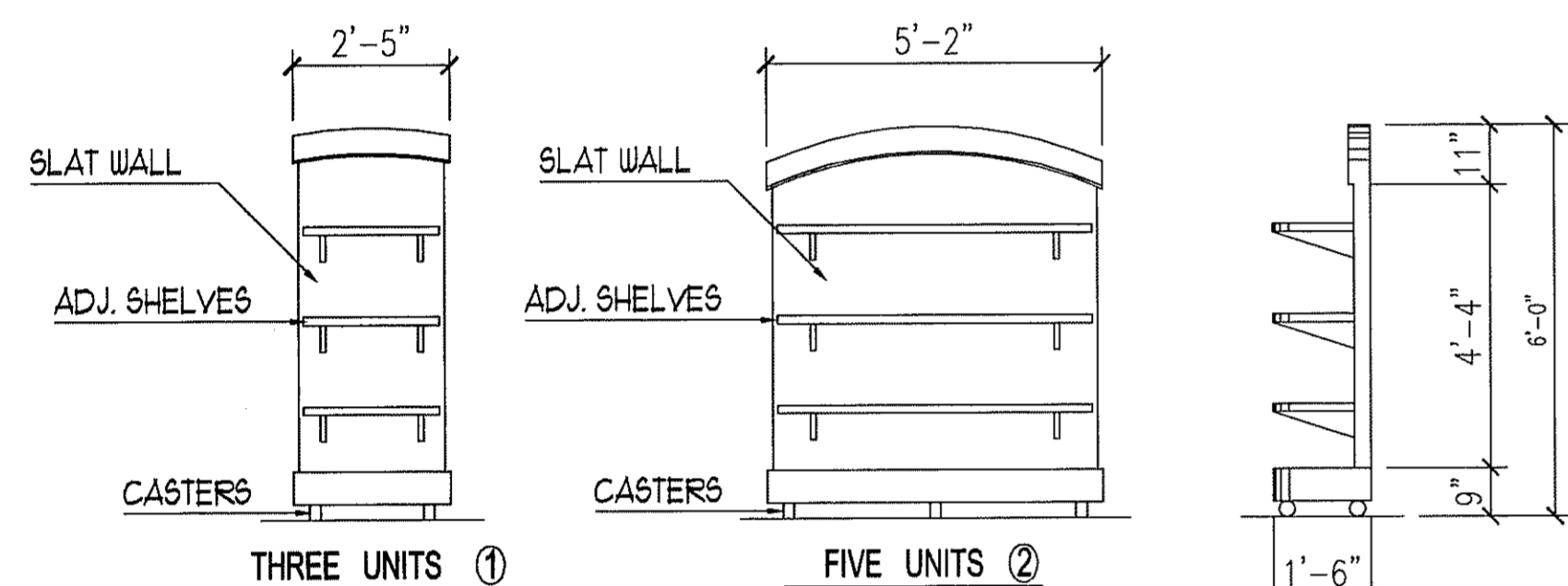

DISPLAY / STORAGE UNIT ELEVATIONS

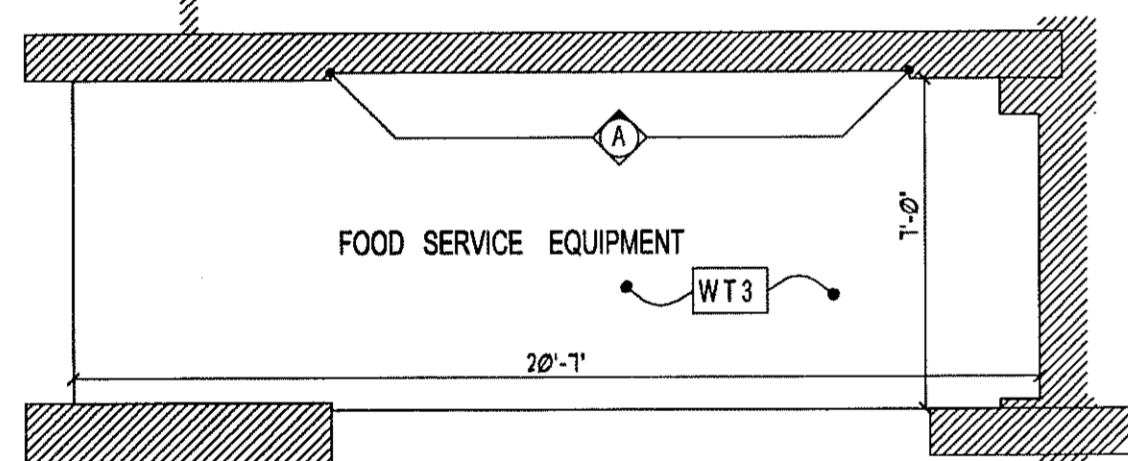

FOOD SERVICE AREA TILE PLAN

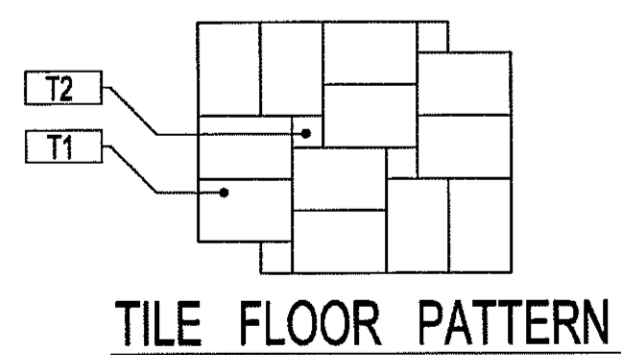

TILE FLOOR PATTERN

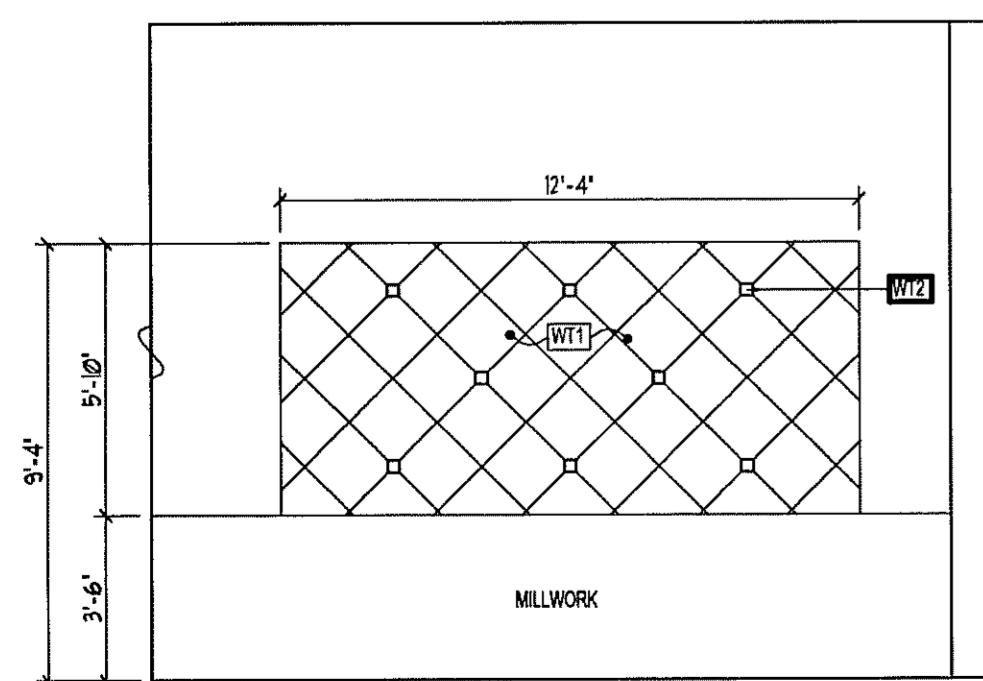

TILE INSERT ELEVATION

INTERIOR FINISH SCHEDULE

FACILITY: Westminster Towers Orlando
 PROJECT NAME: Crossroads Marketplace
 JOB # 50070-14C
 DATE: July 3, 2008

RM	ROOM NAME	FLOOR	BASE		WALL		MILLWORK		Ceiling	Remarks
			Mtl	Clr	North	South	East	West		
100A	Take Out Counter	T3				WT1,2,P1			ACT1,GYP	Paint stucco areas only with P1. Leave brick as is.
100B	Crossroads	T1,2				P1			ACT1,GYP	
CEILING		Description	Mtl.	Series	Pattern/No.	Color	No.	Size	Grout	Remarks
ACT1	Acoustical Tile Suspension System	USG		Sandrift		White	ME 805	2' x 2'		Painted P2
		GYP								
FLOOR		Description	Mtl.	Series	Pattern/No.	Color	No.	Size	Grout	Remarks
T1	Tile	Daltile		Ancient Temple Stone		Artemis Gold	AST3	16" x 24"	A	Refer to Finish Plan for Pattern
T2	Tile	Daltile		Ancient Temple Stone		Artemis Gold	AST3	8" x 8"	A	
T2	Tile	Daltile		Veranda		Rust	P502	13" x 13"	B	
LAMINATE/SOLID SURFACE		Description	Mtl.	Series	Pattern/No.	Color	No.	Size	Grout	Remarks
PL1	Plastic Laminate	Nevamar			WF0001T	Edenwood				
SS1	Solid Surface	Cosentino		Silestone		Absolute Green				
WALL		Description	Mtl.	Series	Pattern/No.	Color	No.	Size	Grout	Remarks
P1	Eggshell Paint	ICI Paints		The Master Palette		TBD	TBD			
P2	Flat Paint	ICI Paints		The Master Palette		Egret	39Y 85/046			
WT1	Wall Tile	Daltile		Ancient Temple Stone		Artemis Gold	AST3	16" x 16"	A	Refer to Elevation A1 for pattern layout
WT2	Wall Tile	Daltile		Ocean Jewels		Abalone/Mother of Pearl	OJ04	3" x 3"	A	
GROUT		Description	Mtl.	No.	Color					
A	Custom Building Products		TBD		TBD					
B	Custom Building Products		TBD		TBD					

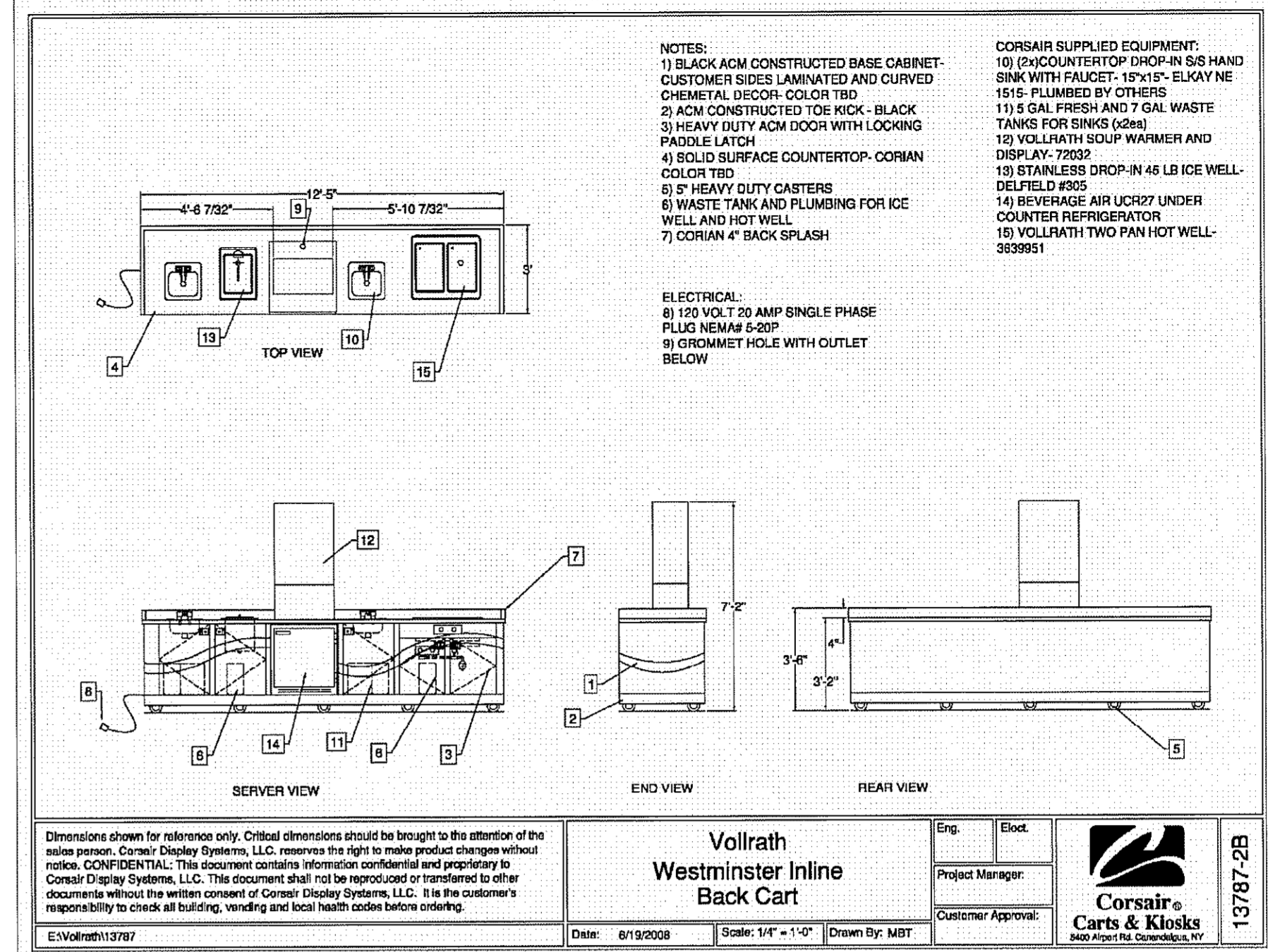

Vollrath Westminster Inline Back Cart
 Date: 6/18/2008 Scale: 1/4" = 1'-0" Drawn By: MBT
 Corsair & Kloske
 13787-2B

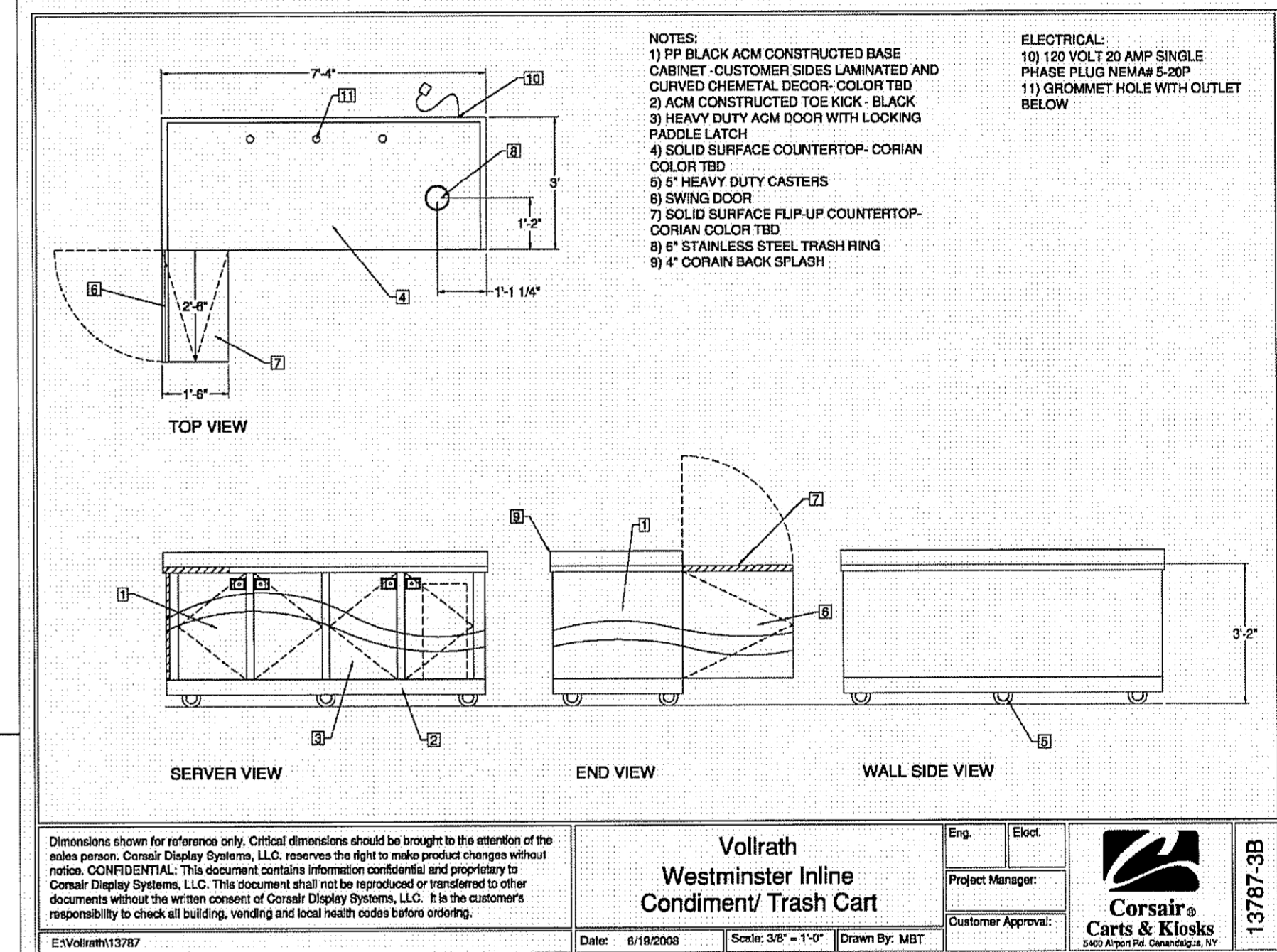

Vollrath Westminster Inline Condiment/Trash Cart
 Date: 6/18/2008 Scale: 3/8" = 1'-0" Drawn By: MBT
 Corsair & Kloske
 13787-3B

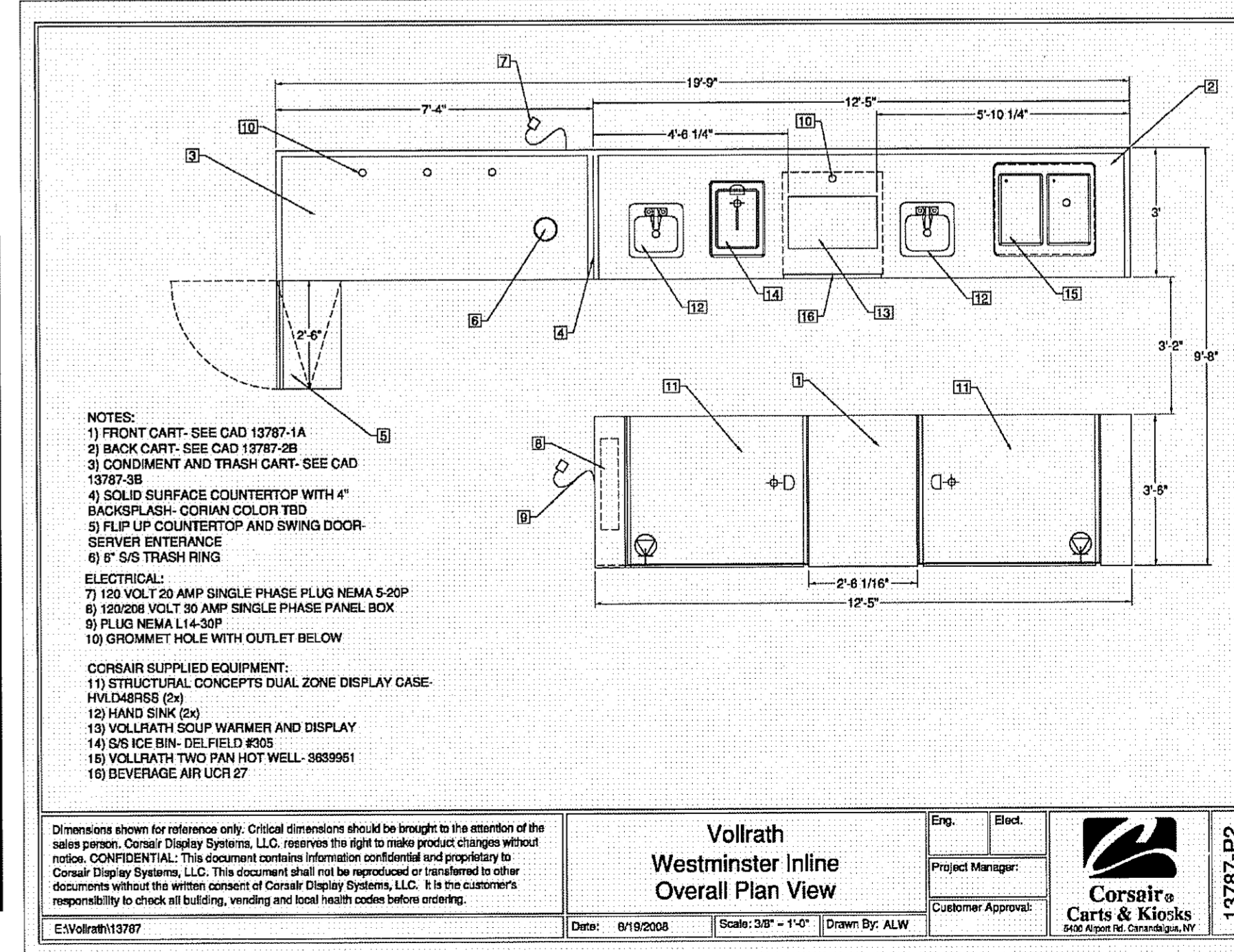

Vollrath Westminster Inline Overall Plan View
 Date: 6/18/2008 Scale: 3/8" = 1'-0" Drawn By: ALW
 Corsair & Kloske
 13787-P2